

# R Package **diagram**: visualising simple graphs, flowcharts, and webs

**Karline Soetaert**

Royal Netherlands Institute of Sea Research (NIOZ)  
Yerseke, The Netherlands

---

## Abstract

This document describes how to use the **diagram** package (Soetaert 2009a) for plotting small networks, flow charts, and (food) webs.

Together with R-package **shape** (Soetaert 2009b) this package has been written to produce the figures of the book (Soetaert and Herman 2009b).

The electrical network symbols were added to produce a figure of the book (Soetaert, Cash, and Mazzia 2012)

*Keywords*: diagram, food web, flow chart, arrows, R.

---

## 1. Introduction

There are three ways in which package **diagram** can be used:

- function `plotmat` takes as input a matrix with transition coefficients or interaction strengths. It plots the corresponding network consisting of (labeled) boxes (the components) connected by arrows. Each arrow is labeled with the value of the coefficients.
- function `plotweb` takes as input a matrix with (flow) values, and plots a web. Here the components are connected by arrows whose thickness is determined by the value of the coefficients.
- Flowcharts can be made by adding separate objects (textboxes) to the figure and connecting these with arrows.

Three datasets have been included:

- `Rigaweb`, the planktonic food web of the Gulf of Riga (Donali, Olli, Heiskanen, and Andersen 1999).
- `Takapotoweb`, the Takapoto atoll planktonic food web (Niquil, Jackson, Legendre, and Delesalle 1998).
- `Teasel`, the transition matrix describing the population dynamics of Teasel, a European perennial weed ((Caswell 2001; Soetaert and Herman 2009b).

The food webs were generated using R packages **LIM** and **limSolve** (Soetaert, Van den Meersche, and van Oevelen 2009; Soetaert and van Oevelen 2009) which contain functions to read and solve food web problems respectively.

## 2. plotmat - plotting networks based on matrix input

This is the quickest method of plotting a network. The network is specified in a matrix, which gives the magnitudes of the links (from columns to rows).

The position of the elements (boxes) is specified by argument `pos`. Thus, setting `pos=c(1,2,1)` indicates that the 4 elements will be arranged in three equidistant rows; on the first row one element, on the second row two elements and on the third row one element.

### 2.1. Simple examples

Below are some simple examples of the use of `plotmat`. In the first graph - four simple boxes are put; no arrows drawn

The second graph contains round boxes with arrows, labeled "flow"

The third graph has diamond-shaped boxes including self-arrows.

The fourth graph has hexagonal-shaped boxes, with curved arrows. The arrows are enlarged and the arrowhead pointing from box 2 to 4 is colored red.

```
> par(mar = c(1, 1, 1, 1), mfrow = c(2, 2))
> #
> #
> names <- c("A", "B", "C", "D")
> M <- matrix(nrow = 4, ncol = 4, byrow = TRUE, data = 0)
> plotmat(M, pos = c(1, 2, 1), name = names, lwd = 1,
+         box.lwd = 2, cex.txt = 0.8, box.size = 0.1,
+         box.type = "square", box.prop = 0.5)
> #
> M[2, 1] <- M[3, 1] <- M[4, 2] <- M[4, 3] <- "flow"
> plotmat(M, pos = c(1, 2, 1), curve = 0, name = names, lwd = 1,
+         box.lwd = 2, cex.txt = 0.8, box.type = "circle", box.prop = 1.0)
> #
> #
> diag(M) <- "self"
> plotmat(M, pos = c(2, 2), curve = 0, name = names, lwd = 1, box.lwd = 2,
+         cex.txt = 0.8, self.cex = 0.5, self.shiftx = c(-0.1, 0.1, -0.1, 0.1),
+         box.type = "diamond", box.prop = 0.5)
> M <- matrix(nrow = 4, ncol = 4, data = 0)
> M[2, 1] <- 1 ; M[4, 2] <- 2 ; M[3, 4] <- 3 ; M[1, 3] <- 4
> Col <- M
> Col[] <- "black"
> Col[4, 2] <- "darkred"
> pp <- plotmat(M, pos = c(1, 2, 1), curve = 0.2, name = names, lwd = 1,
+             box.lwd = 2, cex.txt = 0.8, arr.type = "triangle",
```

```

+           box.size = 0.1, box.type = "hexa", box.prop = 0.25,
+           arr.col = Col, arr.len = 1)
> mtext(outer = TRUE, side = 3, line = -1.5, cex = 1.5, "plotmat")
> #
> par(mfrow = c(1, 1))

```

The contents of `pp` shows the position of the various items.

```

> pp

$arr
  row col  Angle Value      rad  ArrowX  ArrowY  TextX  TextY
1   2   1  53.1301     1 0.08333333 0.3085298 0.7169284 0.2843333 0.7346667
2   4   2 -53.1301     2 0.08333333 0.3077450 0.2841193 0.2843333 0.2653333
3   1   3 -53.1301     4 0.08333333 0.6918629 0.7164048 0.7156667 0.7346667
4   3   4  53.1301     3 0.08333333 0.6910769 0.2825485 0.7156667 0.2653333

$comp
      x      y
[1,] 0.50 0.8333333
[2,] 0.25 0.5000000
[3,] 0.75 0.5000000
[4,] 0.50 0.1666667

$radii
      x      y
[1,] 0.1 0.025
[2,] 0.1 0.025
[3,] 0.1 0.025
[4,] 0.1 0.025

$rect
  xleft  ybot xright  ytop
[1,] 0.40 0.8083333 0.60 0.8583333
[2,] 0.15 0.4750000 0.35 0.5250000
[3,] 0.65 0.4750000 0.85 0.5250000
[4,] 0.40 0.1416667 0.60 0.1916667

```

## 2.2. a schematic representation of an ecosystem model

In the example below, first the main components and arrows are drawn (`plotmat`), and the output of this function written in list `pp`. This contains, a.o. the positions of the components (boxes), arrows, etc.. It is used to draw an arrow from the middle of the arrow connecting fish and zooplankton ("ZOO") to detritus. Function `straightarrow` (see below) is used to draw this arrow.

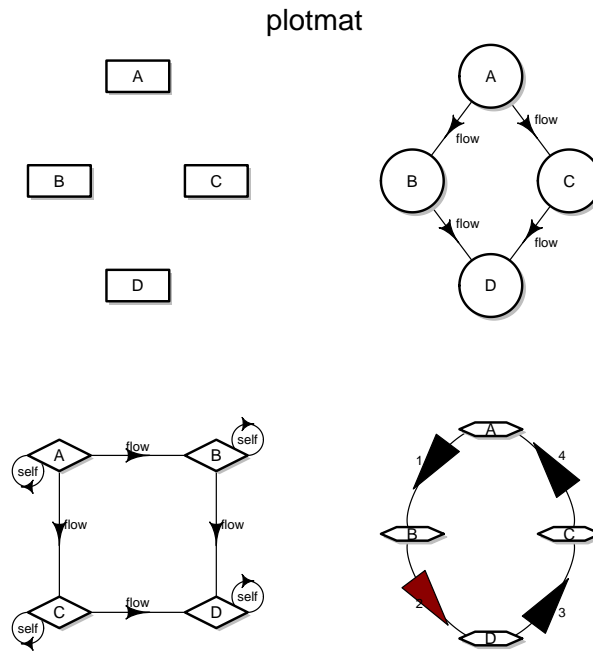

Figure 1: Four simple examples of plotmat

```

> names <- c("PHYTO", "NH3", "ZOO", "DETRITUS", "BotDET", "FISH")
> M <- matrix(nrow = 6, ncol = 6, byrow = TRUE, data = c(
+ #   p  n  z  d  b  f
+   0, 1, 0, 0, 0, 0, #p
+   0, 0, 4, 10, 11, 0, #n
+   2, 0, 0, 0, 0, 0, #z
+   8, 0, 13, 0, 0, 12, #d
+   9, 0, 0, 7, 0, 0, #b
+   0, 0, 5, 0, 0, 0 #f
+   ))
> #
> pp <- plotmat(M, pos = c(1, 2, 1, 2), curve = 0, name = names,
+             lwd = 1, box.lwd = 2, cex.txt = 0.8,
+             box.type = "square", box.prop = 0.5, arr.type = "triangle",
+             arr.pos = 0.4, shadow.size = 0.01, prefix = "f",
+             main = "NPZZDD model")
> #
> phyto <- pp$comp[names=="PHYTO"]
> zoo <- pp$comp[names=="ZOO"]
> nh3 <- pp$comp[names=="NH3"]
> detritus <- pp$comp[names=="DETRITUS"]
> fish <- pp$comp[names=="FISH"]
> #

```

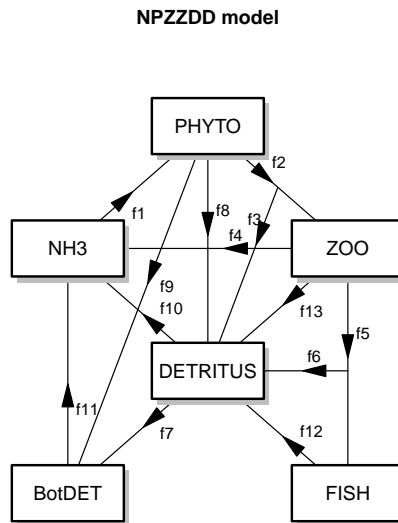

Figure 2: An NPZZDD model

```

> # flow5->detritus
> #
> m2 <- 0.5*(zoo+fish)
> m1 <- detritus
> m1[1] <- m1[1] + pp$radii[4,1]
> mid <- straightarrow (to = m1, from = m2, arr.type = "triangle",
+                       arr.pos = 0.4, lwd = 1)
> text(mid[1], mid[2]+0.03, "f6", cex = 0.8)
> #
> # flow2->detritus
> #
> m2 <- 0.5*(zoo+phyto)
> m1 <- detritus
> m1[1] <-m1[1] + pp$radii[3,1]*0.2
> m1[2] <-m1[2] + pp$radii[3,2]
> mid <- straightarrow (to = m1, from = m2, arr.type = "triangle",
+                       arr.pos = 0.3, lwd = 1)
> text(mid[1]-0.01, mid[2]+0.03, "f3", cex = 0.8)

```

### 2.3. Plotting a transition matrix

The next example uses formulae to label the arrows <sup>1</sup>. This is done by passing a data.frame rather than a matrix to function `plotmat`

```
> # Create population matrix
> #
> Numgenerations <- 6
> DiffMat <- matrix(data = 0, nrow = Numgenerations, ncol = Numgenerations)
> AA <- as.data.frame(DiffMat)
> AA[[1,4]] <- "f[3]"
> AA[[1,5]] <- "f[4]"
> AA[[1,6]] <- "f[5]"
> #
> AA[[2,1]] <- "s[list(0,1)]"
> AA[[3,2]] <- "s[list(1,2)]"
> AA[[4,3]] <- "s[list(2,3)]"
> AA[[5,4]] <- "s[list(3,4)]"
> AA[[6,5]] <- "s[list(4,5)]"
> #
> name <- c(expression(Age[0]), expression(Age[1]), expression(Age[2]),
+           expression(Age[3]), expression(Age[4]), expression(Age[5]))
> #
> plotmat(A = AA, pos = 6, curve = 0.7, name = name, lwd = 2,
+         arr.len = 0.6, arr.width = 0.25, my = -0.2,
+         box.size = 0.05, arr.type = "triangle", dtext = 0.95,
+         main = "Age-structured population model 1")
```

### 2.4. Another transition matrix

The data set `Teasel` contains the transition matrix of the population dynamics model of `teasel` (*Dipsacus sylvestris*), a European perennial weed, (Caswell 2001; Soetaert and Herman 2009b)

```
> Teasel
```

	DS 1yr	DS 2yr	R small	R medium	R large	F
DS 1yr	0.000	0.00	0.000	0.000	0.000	322.380
DS 2yr	0.966	0.00	0.000	0.000	0.000	0.000
R small	0.013	0.01	0.125	0.000	0.000	3.448
R medium	0.007	0.00	0.125	0.238	0.000	30.170
R large	0.008	0.00	0.038	0.245	0.167	0.862
F	0.000	0.00	0.000	0.023	0.750	0.000

This dataset is plotted using curved arrows; we specify the curvature in a matrix called `curves`.

<sup>1</sup>This is now possible thanks to Yvonnick Noel, Univ. Rennes, France

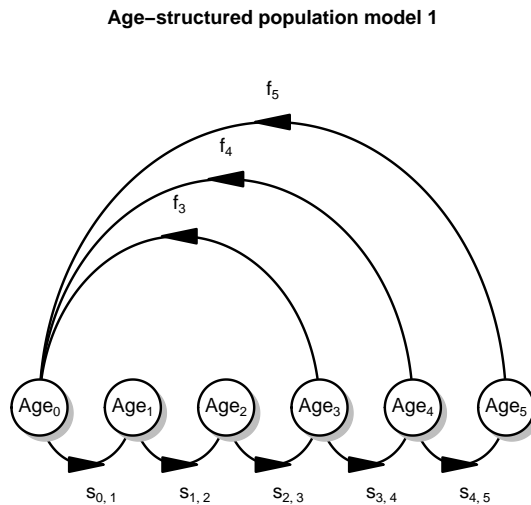

Figure 3: A transition matrix

```

> curves <- matrix(nrow = ncol(Teasel), ncol = ncol(Teasel), 0)
> curves[3, 1] <- curves[1, 6] <- -0.35
> curves[4, 6] <- curves[6, 4] <- curves[5, 6] <- curves[6, 5] <- 0.08
> curves[3, 6] <- 0.35
> plotmat(Teasel, pos = c(3, 2, 1), curve = curves,
+         name = colnames(Teasel), lwd = 1, box.lwd = 2,
+         cex.txt = 0.8, box.cex = 0.8, box.size = 0.08,
+         arr.length = 0.5, box.type = "circle", box.prop = 1,
+         shadow.size = 0.01, self.cex = 0.6, my = -0.075, mx = -0.01,
+         relsize = 0.9, self.shiftx = c(0, 0, 0.125, -0.12, 0.125, 0),
+         self.shifty = 0, main = "Teasel population model")

```

### 3. plotweb - plotting webs based on matrix input

Given a matrix containing flow values (from rows to columns), function `plotweb` will plot a web. The elements are positioned on a circle, and connected by arrows; the magnitude of web flows determines the thickness of the arrow.

This function is less flexible than `plotmat`, although it does allow to color the arrows differently.

```

> BB <- matrix(nrow = 20, ncol = 20, 1:20)
> diag(BB) <- 0

```

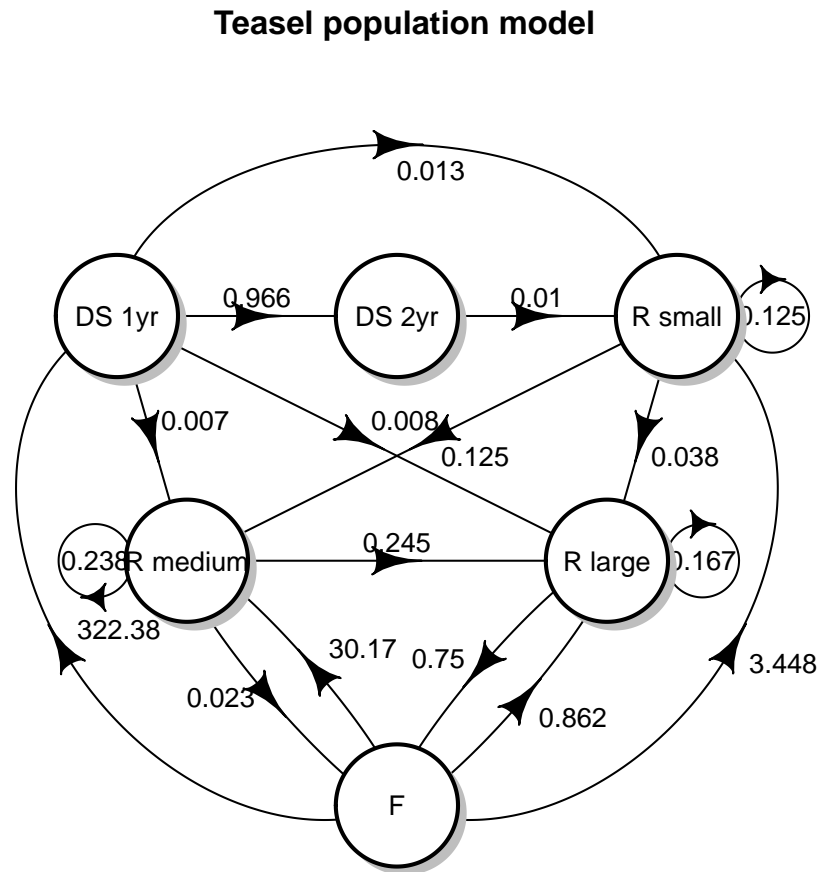

Figure 4: The Teasel data set



NULL

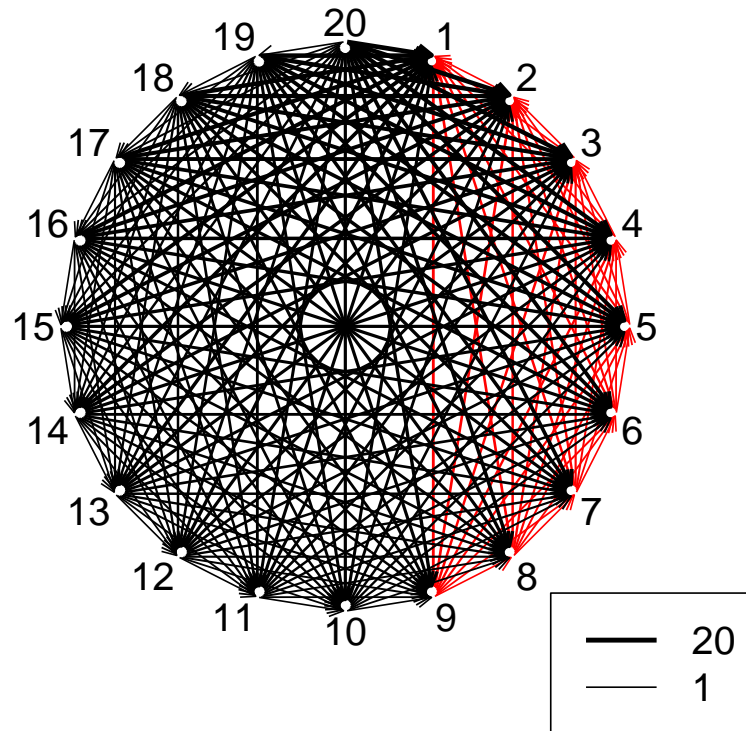

Figure 5: Plotweb

```
> Col <- BB
> Col[] <- "black"
> Col[BB<10]<- "red"
> plotweb(BB, legend = TRUE, maxarrow = 3, arr.col = Col)
```

NULL

```
> par(mfrow = c(1, 1))
```

### 3.1. Foodwebs

Dataset `Rigaweb` ((Donali *et al.* 1999)) contains flow values for the food web of the Gulf of Riga planktonic system.

```
> Rigaweb
```

	P1	P2	B	N	Z	D	DOC	CO2
P1	0.0000	0.0000	0.0000	4.12297	10.49431	0.000000	1.565910	17.22501
P2	0.0000	0.0000	0.0000	0.00000	16.79755	4.457164	2.723090	29.95399
B	0.0000	0.0000	0.0000	9.44000	0.00000	0.000000	0.000000	244.99223
N	0.0000	0.0000	0.0000	0.00000	0.00000	0.000000	0.000000	13.40297
Z	0.0000	0.0000	0.0000	0.00000	0.00000	3.183226	3.963226	30.19580
D	0.0000	0.0000	0.0000	0.00000	12.34039	0.000000	0.000000	0.00000
DOC	0.0000	0.0000	261.1822	0.00000	0.00000	0.000000	0.000000	0.00000
CO2	31.3182	54.4618	0.0000	0.00000	0.00000	0.000000	0.000000	0.00000
Sedimentation	0.0000	0.0000	0.0000	0.00000	0.00000	0.000000	0.000000	0.00000

	Sedimentation
P1	0.10
P2	0.34
B	0.00
N	0.00
Z	0.78
D	13.92
DOC	0.00
CO2	0.00
Sedimentation	0.00

```
> plotweb(Rigaweb, main = "Gulf of Riga food web",
+         sub = "mgC/m3/d", val = TRUE)
```

## 4. functions to create flow charts

The various functions are given in table (1) <sup>2</sup>.

The code below generates a flow chart

```
> par(mar = c(1, 1, 1, 1))
> openplotmat()
> elpos <- coordinates (c(1, 1, 2, 4))
> fromto <- matrix(ncol = 2, byrow = TRUE,
+                 data = c(1, 2, 2, 3, 2, 4, 4, 7, 4, 8))
> nr <- nrow(fromto)
> arrpos <- matrix(ncol = 2, nrow = nr)
> for (i in 1:nr)
+   arrpos[i, ] <- straightarrow (to = elpos[fromto[i, 2], ],
+                               from = elpos[fromto[i, 1], ],
+                               lwd = 2, arr.pos = 0.6, arr.length = 0.5)
> textellipse(elpos[1,], 0.1, lab = "start", box.col = "green",
+             shadow.col = "darkgreen", shadow.size = 0.005, cex = 1.5)
> textrect (elpos[2,], 0.15, 0.05, lab = "found term?", box.col = "blue",
+          shadow.col = "darkblue", shadow.size = 0.005, cex = 1.5)
```

<sup>2</sup>textparallel was implemented by Michael Folkes, Canada

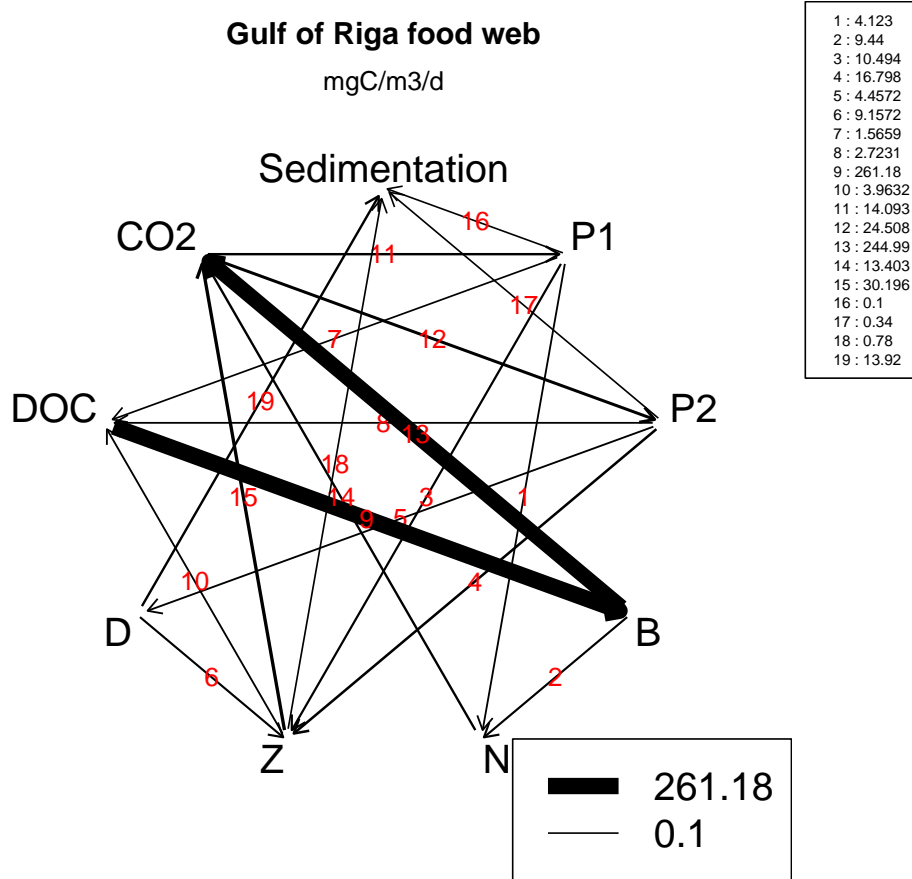

Figure 6: The Gulf of Riga data set

Table 1: Summary of flowchart functions

Function	Description
<code>openplotmat</code>	creates an empty plot
<code>coordinates</code>	calculates coordinates of elements, neatly arranged in rows/columns
<code>bentarrow</code>	adds 2-segmented arrow between two points
<code>curvedarrow</code>	adds curved arrow between two points
<code>segmentarrow</code>	adds 3-segmented arrow between two points
<code>selfarrow</code>	adds a circular self-pointing arrow
<code>splitarrow</code>	adds a branched arrow between several points
<code>straightarrow</code>	adds straight arrow between two points
<code>treearrow</code>	adds dendrogram-like branched arrow between several points
<code>shadowbox</code>	adds a box with a shadow to a plot
<code>textdiamond</code>	adds lines of text in a diamond-shaped box to a plot
<code>textellipse</code>	adds lines of text in an ellipse-shaped box to a plot
<code>textempty</code>	adds lines of text on a colored background to a plot
<code>texthexa</code>	adds lines of text in a hexagonal box to a plot
<code>textmulti</code>	adds lines of text in a multigonal box to a plot
<code>textparallel</code>	adds lines of text in a parallelogram to a plot
<code>textplain</code>	adds lines of text to a plot
<code>textrect</code>	adds lines of text in a rectangular-shaped box to a plot
<code>textround</code>	adds lines of text in a rounded box to a plot

```

> textrect (elpos[4,], 0.15, 0.05, lab = "related?", box.col = "blue",
+          shadow.col = "darkblue", shadow.size = 0.005, cex = 1.5)
> textellipse(elpos[3,], 0.1, 0.1, lab = c("other","term"), box.col = "orange",
+            shadow.col = "red", shadow.size = 0.005, cex = 1.5)
> textellipse(elpos[3,], 0.1, 0.1, lab = c("other","term"), box.col = "orange",
+            shadow.col = "red", shadow.size = 0.005, cex = 1.5)
> textellipse(elpos[7,], 0.1, 0.1, lab = c("make","a link"), box.col = "orange",
+            shadow.col = "red", shadow.size = 0.005, cex = 1.5)
> textellipse(elpos[8,], 0.1, 0.1, lab = c("new","article"), box.col = "orange",
+            shadow.col = "red", shadow.size = 0.005, cex = 1.5)
> #
> dd <- c(0.0, 0.025)
> text(arrpos[2, 1] + 0.05, arrpos[2, 2], "yes")
> text(arrpos[3, 1] - 0.05, arrpos[3, 2], "no")
> text(arrpos[4, 1] + 0.05, arrpos[4, 2] + 0.05, "yes")
> text(arrpos[5, 1] - 0.05, arrpos[5, 2] + 0.05, "no")
> #

```

The different types of text boxes are generated with the following code:

```

> openplotmat(main = "textbox shapes")
> rx <- 0.1
> ry <- 0.05

```

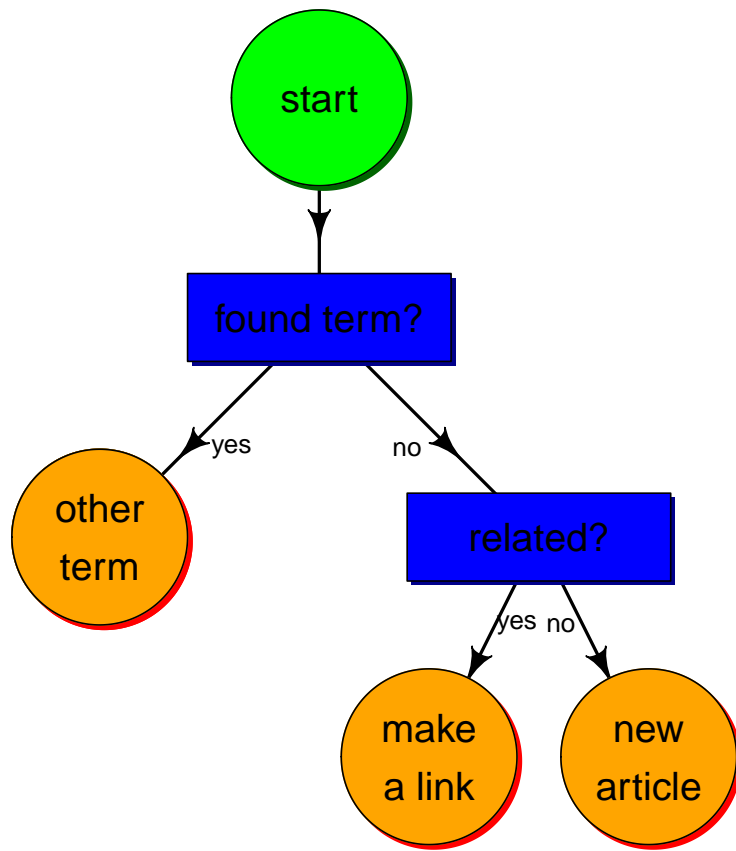

Figure 7: A flow chart

```

> pos <- coordinates(c(1, 1, 1, 1, 1, 1, 1,1 ), mx = -0.2)
> textdiamond(mid = pos[1,], radx = rx, rady = ry, lab = LETTERS[1],
+             cex = 2, shadow.col = "lightblue")
> textellipse(mid = pos[2,], radx = rx, rady = ry, lab = LETTERS[2],
+             cex = 2, shadow.col = "blue")
> texthexa(mid = pos[3,], radx = rx, rady = ry, lab = LETTERS[3],
+          cex = 2, shadow.col = "darkblue")
> textmulti(mid = pos[4,], nr = 7, radx = rx, rady = ry, lab = LETTERS[4],
+          cex = 2, shadow.col = "red")
> textrect(mid = pos[5,], radx = rx, rady = ry, lab = LETTERS[5],
+          cex = 2, shadow.col = "darkred")
> textround(mid = pos[6,], radx = rx, rady = ry, lab = LETTERS[6],
+          cex = 2, shadow.col = "black")
> textparallel(mid = pos[7,], radx = rx, rady = ry, lab = LETTERS[7],
+             cex = 2, theta = 40, shadow.col = "black")
> textempty(mid = pos[8,], lab = LETTERS[8], cex = 2, box.col = "yellow")
> pos[ ,1] <- pos[ ,1] + 0.5
> text(pos[ ,1],pos[ ,2], c("textdiamond", "textellipse", "texthexa",
+                          "textmulti", "textrect", "textround",
+                          "textparallel", "textempty"))

```

The different types of arrows are generated with the following code:

```

> par(mar = c(1, 1, 1, 1))
> openplotmat(main = "Arrowtypes")
> elpos <- coordinates (c(1, 2, 1), mx = 0.1, my = -0.1)
> curvedarrow(from = elpos[1, ], to = elpos[2, ], curve = -0.5,
+            lty = 2, lcol = 2)
> straightarrow(from = elpos[1, ], to = elpos[2, ], lty = 3, lcol = 3)
> segmentarrow (from = elpos[1, ], to = elpos[2, ], lty = 1, lcol = 1)
> treearrow    (from = elpos[2:3, ], to = elpos[4, ], lty = 4, lcol = 4)
> bentarrow (from = elpos[3, ], to = elpos[3, ]-c(0.1, 0.1),
+          arr.pos = 1, lty = 5, lcol = 5)
> bentarrow(from = elpos[1, ], to = elpos[3, ], lty = 5, lcol = 5)
> selfarrow(pos = elpos[3, ], path = "R",lty = 6, curve = 0.075, lcol = 6)
> splitarrow(from = elpos[1, ], to = elpos[2:3, ], lty = 1,
+           lwd = 1, dd = 0.7, arr.side = 1:2, lcol = 7)
> for ( i in 1:4)
+   textrect (elpos[i, ], 0.05, 0.05, lab = i, cex = 1.5)
> legend("topright", lty = 1:7, legend = c("segmentarrow",
+     "curvedarrow", "straightarrow", "treearrow", "bentarrow",
+     "selfarrow", "splitarrow"), lwd = c(rep(2, 6), 1), col = 1:7)

```

## 5. functions to draw electrical networks

Since version 1.6, it is possible to use **diagram** to draw electrical networks. Below I give an example of a small transistor circuit.

**textbox shapes**

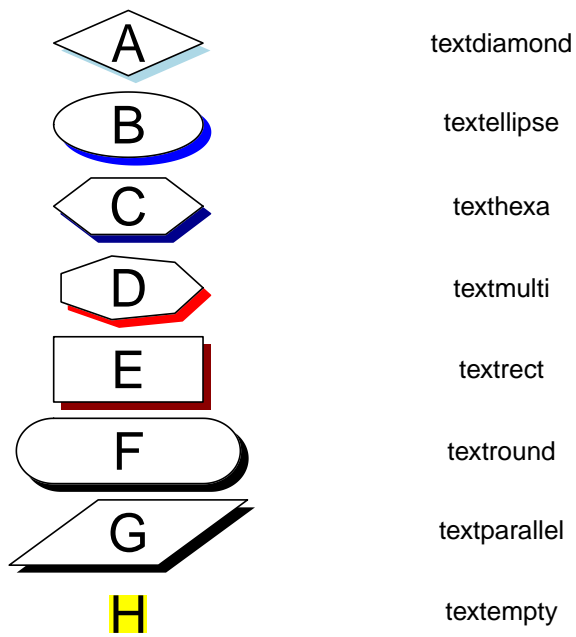

Figure 8: The text boxes

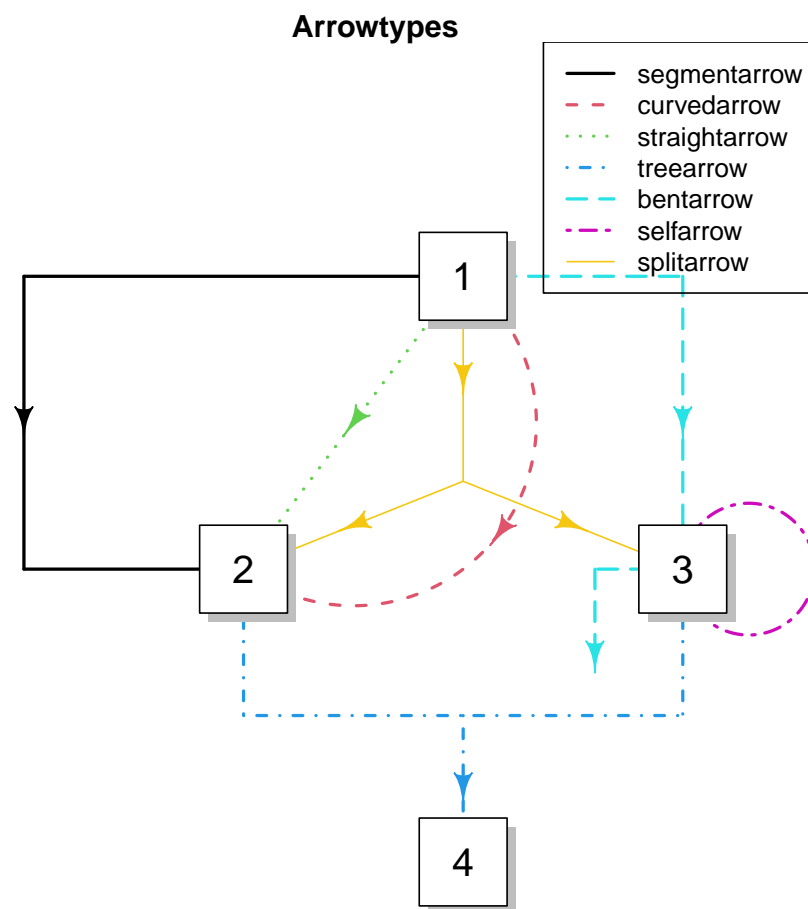

Figure 9: The arrow types



```

> layoutmat <- matrix(data = c(rep(1, 12), 2, 3, 4, 5),
+                       nrow = 4, ncol = 4, byrow = TRUE)
> nf <- layout(layoutmat, respect = FALSE)
> par(lwd = 1.5)
> par(mar = c(0, 0, 2, 0))
> emptyplot(main = "transistor Amplifier", asp = FALSE,
+            ylim = c(-0.1, 1), xlim = c(-0.1, 1.1))
> x1 <- 0; x2 <- 0.2; x3 <- 0.4; x4 <- 0.6; x5 <- 0.8; x6 <- 1
> y1 <- 0.05; y2 <- 0.4; y3 <- 0.5; y4 <- 0.6; y5 <- 0.95
> x23 <- (x2 + x3)/2
> x56 <- (x5 + x6)/2
> lines(c(x2, x6, x6, x2, x2, x1, x1, x23, x3, x3),
+       c(y1, y1, y5, y5, y1, y1, y3, y3, y4, y5))
> lines(c(x23, x3, x3),          c(y3, y2, y1))
> lines(c(x3, x4, x4),          c(y2, y2, y1))
> lines(c(x3, x5, x5),          c(y4, y4, y1))
> en.Amplifier(c(x23, y3), r = 0.035)
> en.Signal(c(x1, 0.2), lab = expression("U"["in"]))
> en.Signal(c(x6, y2), lab = expression("U"["b"]))
> straightarrow(c(x1 - 0.05, 0.23), c(x1 - 0.05, 0.17),
+               arr.pos = 1, arr.type = "triangle", lwd = 1)
> straightarrow(c(x6 + 0.05, y2 + 0.03), c(x6 + 0.05, y2 - 0.03),
+               arr.pos = 1, arr.type = "triangle", lwd = 1)
> en.Node(c(x1, y3), lab = "u1")
> en.Node(c(x2, y3), lab = "u2")
> en.Node(c(x3, y2), lab = "u3", pos = 1.5)
> en.Node(c(x3, y4), lab = "u4", pos = 2.5)
> en.Node(c(x5, y4), lab = "u5")
> en.Capacitator(c(0.5*(x1 + x2),y3), lab = "C1", vert = FALSE)
> en.Capacitator(c(x4, y4), lab = "C3", vert = FALSE)
> en.Capacitator(c(x4, 0.5*(y1+y2)), lab = "C2", vert = TRUE)
> en.Resistor(c(x1, y2), lab = "R0")
> en.Resistor(c(x2, 0.5*(y1+y2)), lab = "R1")
> en.Resistor(c(x2, 0.5*(y4+y5)), lab = "R2")
> en.Resistor(c(x3, 0.5*(y4+y5)), lab = "R4")
> en.Resistor(c(x3, 0.5*(y1+y2)), lab = "R3")
> en.Resistor(c(x5, 0.5*(y1+y2)), lab = "R5")
> en.Ground(c(1.0, 0.05))
> par(mar=c(2, 2, 2, 2))
> emptyplot(main = "transistor")
> lines(c(0.1, 0.5,0.9), c(0.5, 0.5, 0.9))
> lines(c(0.5, 0.9), c(0.5, 0.1))
> lines(c(0.5, 0.5), c(0.4, 0.6))
> text(0.2, 0.4, "Gate", font = 3)
> text(0.8, 0.9, "Drain", font = 3,adj = 1)
> text(0.8, 0.1, "Source", font = 3,adj = 1)
> en.Amplifier(c(0.5, 0.5), r = 0.15)

```

```

> box(col = "grey")
> emptyplot(main = "capacitator")
> straightarrow(c(0.5, 0.9), c(0.5, 0.1),
+               arr.pos = 0.3, arr.length = 0.25, arr.type = "triangle")
> en.Capacitator(c(0.5, 0.5), width = 0.075, length = 0.5, vert = TRUE)
> text(0.4, 0.65, "i", font = 3, cex = 2)
> straightarrow(c(0.8, 0.3), c(0.8, 0.77), arr.pos = 1,
+               arr.length = 0.25, arr.type = "triangle", lwd = 1)
> text(0.925, 0.65, "v", font = 3, cex = 2)
> text(0.15, 0.5, "C", font = 3, cex = 2)
> box(col = "grey")
> emptyplot(main = "resistor")
> straightarrow(c(0.5, 0.9), c(0.5, 0.1), arr.pos = 0.2,
+               arr.length = 0.25, arr.type = "triangle", lwd = 1)
> text(0.4, 0.85, "i", font = 3, cex = 2)
> en.Resistor(c(0.5, 0.5), width = 0.25, length = 0.35 )
> straightarrow(c(0.8, 0.3), c(0.8, 0.77), arr.pos = 1,
+               arr.length = 0.25, arr.type = "triangle", lwd = 1)
> text(0.925, 0.65, "v", font = 3, cex = 2)
> text(0.5, 0.5, "R", font = 3, cex = 2)
> box(col = "grey")
> emptyplot(main = "voltage source")
> lines(c(0.5, 0.5), c(0.1, 0.9))
> en.Signal(c(0.5, 0.5), r = 0.15)
> straightarrow(c(0.8, 0.3), c(0.8, 0.77), arr.pos = 1,
+               arr.length = 0.25, arr.type = "triangle", lwd = 1)
> text(0.925, 0.65, "v", font = 3, cex = 2)
> box(col = "grey")

```

This vignette was created using Sweave (Leisch 2002).

The package is on CRAN, the R-archive website ((R Development Core Team 2008))

More examples can be found in the demo's of package **ecolMod** (Soetaert and Herman 2009a)

## References

- Caswell H (2001). *Matrix population models: construction, analysis, and interpretation*. Second edition edition. Sinauer, Sunderland.
- Donali E, Olli K, Heiskanen AS, Andersen T (1999). "Carbon flow patterns in the planktonic food web of the Gulf of Riga, the Baltic Sea: a reconstruction by the inverse method." *Journal of Marine Systems*, **23**, 251–268.
- Leisch F (2002). "Sweave: Dynamic Generation of Statistical Reports Using Literate Data Analysis." In W Härdle, B Rönz (eds.), *Compstat 2002 — Proceedings in Computational Statistics*, pp. 575–580. Physica Verlag, Heidelberg. ISBN 3-7908-1517-9, URL <http://www.stat.uni-muenchen.de/~leisch/Sweave>.

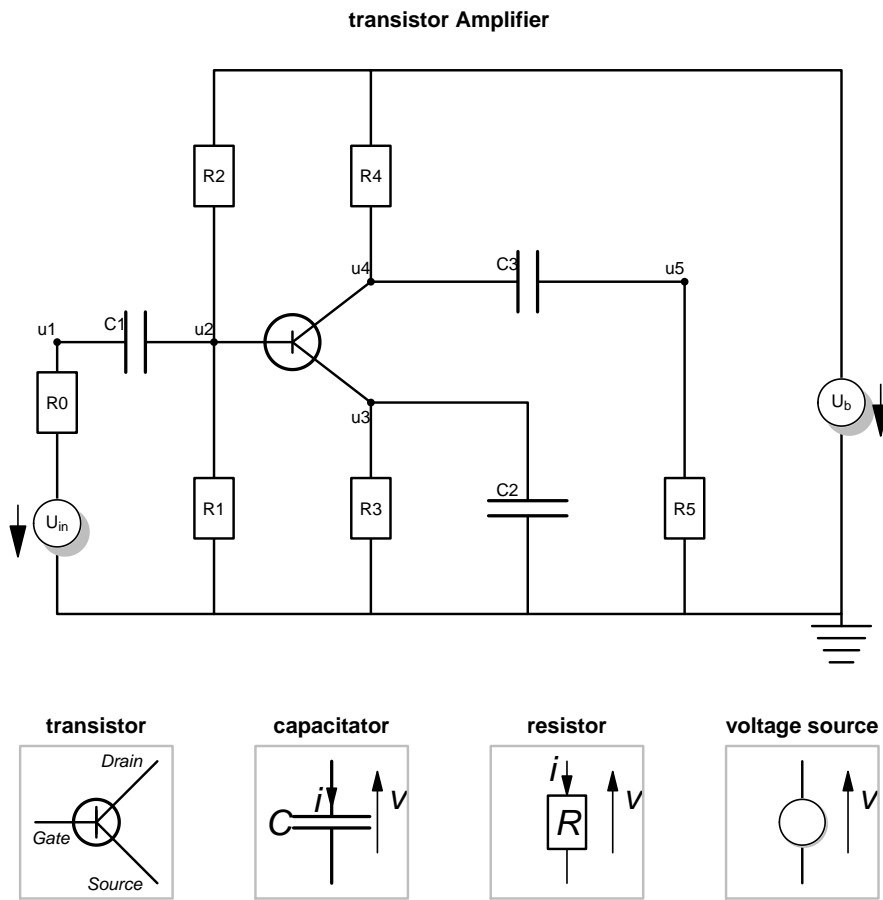

Figure 10: Drawing an electrical network with package diagram

- Niquil N, Jackson G, Legendre L, Delesalle B (1998). “Inverse model analysis of the planktonic food web of Takapoto Atoll (French Polynesia).” *Marine Ecology Progress Series*, **165**, 17–29.
- R Development Core Team (2008). *R: A Language and Environment for Statistical Computing*. R Foundation for Statistical Computing, Vienna, Austria. ISBN 3-900051-07-0, URL <http://www.R-project.org>.
- Soetaert K (2009a). *diagram: Functions for visualising simple graphs (networks), plotting flow diagrams*. R package version 1.5.
- Soetaert K (2009b). *shape: Functions for plotting graphical shapes, colors*. R package version 1.2.2.
- Soetaert K, Cash JR, Mazzia F (2012). *Solving Differential Equations in R*. Springer. In press.
- Soetaert K, Herman PM (2009a). *ecolMod: "A practical guide to ecological modelling - using R as a simulation platform"*. R package version 1.3.
- Soetaert K, Herman PMJ (2009b). *A Practical Guide to Ecological Modelling. Using R as a Simulation Platform*. Springer. ISBN 978-1-4020-8623-6.
- Soetaert K, Van den Meersche K, van Oevelen D (2009). *limSolve: Solving linear inverse models*. R package version 1.5.
- Soetaert K, van Oevelen D (2009). *LIM: Linear Inverse Model examples and solution methods*. R package version 1.4.

**Affiliation:**

Karline Soetaert

Royal Netherlands Institute of Sea Research (NIOZ)

4401 NT Yerseke, Netherlands E-mail: [karline.soetaert@nioz.nl](mailto:karline.soetaert@nioz.nl)

URL: <http://www.nioz.nl>